

## SPICE thermal model

BUK7Y59-60E

Symbol	Parameter	Conditions	Min	Typ	Max	Unit
$R_{th(j-mb)}$	thermal resistance from junction to mounting base		-	-	4.03	K/W

$C_{th1}$	1.143E-05 F
$C_{th2}$	6.442E-05 F
$C_{th3}$	8.376E-05 F
$C_{th4}$	5.754E-04 F
$C_{th5}$	7.288E-04 F
$C_{th6}$	4.439E-03 F
$C_{th7}$	5.310E-02 F
$R_{th1}$	7.880E-03 $\Omega$
$R_{th2}$	1.874E-02 $\Omega$
$R_{th3}$	1.106E-01 $\Omega$
$R_{th4}$	2.005E-01 $\Omega$
$R_{th5}$	1.150E+00 $\Omega$
$R_{th6}$	2.326E+00 $\Omega$
$R_{th7}$	2.122E-01 $\Omega$

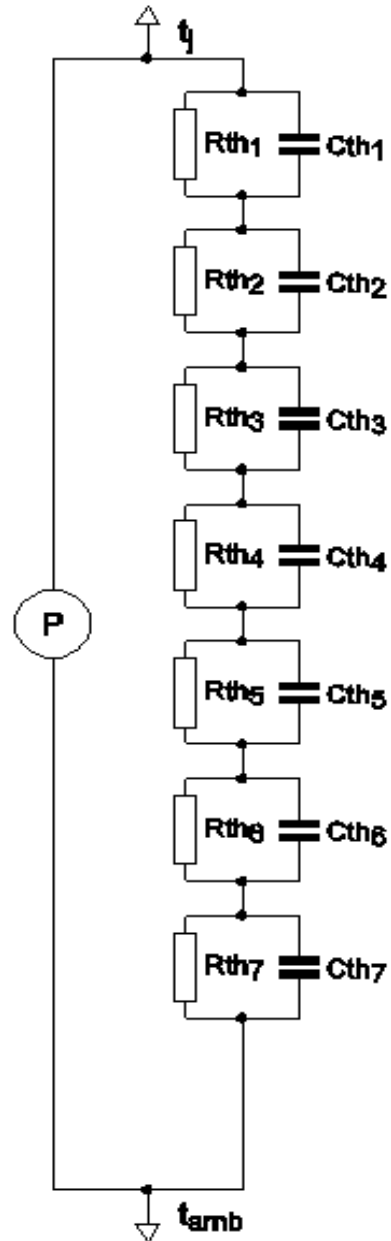

Part: BUK7Y59-60E  
 Date: 25/1/2013  
 Rth 4.03 K/W